

SR-EOS05B Energy Storage Battery

User Manual

V1.0

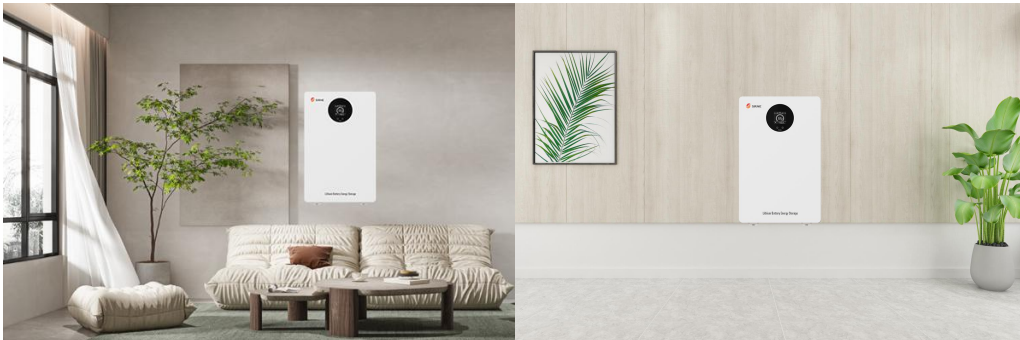

1. Instructions

Thank you very much for choosing the EOS series household energy storage system developed and produced by our company. Please read and understand all contents of the Manual carefully before installing and using the product. If you have any suggestions during the use, please do not hesitate to give us feedback.

1.1 Range of Application

The installation and user manual of SR-EOS series is applicable to the installation and use of the following products:

No	Model	Rated energy
1	SR-EOS05B	5.12kWh
2	SR-EOS10B	10.24kWh

The product should be used in compliance with local standards, laws and regulations, because any non-compliance with the use may lead to personal injuries and property loss.

The drawings provided in this Manual are used to explain the concepts related to the product, including product information, installation guide, electrical connection, system debugging, safety information, common problems and maintenance, etc.

The internal parameters of this product have been adjusted before delivery. No internal parameters can be changed without permission. Any unauthorized changes to the settings will invalidate the warranty, and the Company will not be liable for any loss resulting therefrom.





This Manual and other related documents are an integral part of the product and should be kept properly for onsite installation personnel and related technical personnel to consult.

1.2 Meaning of Abbreviations

AC	Alternating Current
DC	Direct Current
PV	Photovoltaic
BMS	Battery Management System
PCS	Power Conversion System
RJ45	Registered Jack 45
SOC	State Of Charge
C	Charge C-rate
RS485	RS485 Communication Interface
CAN	Controller Area Network

1.3 Symbol Stipulations









There may be following symbols herein, and their meanings are as follows.

Symbols	Description
	Indicate a hazard with a high level of risk which, if not avoided, will result in death or serious injuries.
	Indicate a hazard with a medium level of risk which, if not avoided, could result in death or serious injuries.
	Indicate a hazard with a low level of risk which, if not avoided, could result in minor or moderate injuries.
	Warning information about device or environment safety. If not avoided, equipment damage, data loss, performance degradation or other unanticipated results may be resulted in. The "NOTICE" does not involve any personal injuries.

2 Safety Precautions

2.1 Safety Symbols

This product contains the following symbols, please pay attention to identifying.

Symbols	Description
	Observe enclosed documentation
	Danger. Risk of electric shock!
	Danger of high voltages. Danger to life due to high voltages in the Energy storage system
	Hot surface
	CE certification
	Do not touch the product in 5mins after shutdown
	Comply with RoHS standard
	The Energy storage system should not be disposed together with the household waste.

2.1 General Safety



2.1.1 Important Notice







Before installing, operating and maintaining the device, please read this Manual first and follow the symbols on the device and all the safety precautions in this Manual.

The matters indicated with "DANGER", "CAUTION", "ATTENTION" and "NOTICE" in this Manual do not represent all the safety matters to be observed, but are only the supplements to all the safety precautions. The Company will not be liable for any violation of general safety operating requirements, or any violation of safety standards for the design, production and use of the device. The device must be used in an environment that meets the requirements of the design specifications. Otherwise, the device may fail, and the abnormal device function or component damage, personal safety accident, and property loss arising from this are not covered within the quality assurance scope of the device. When installing, operating, and maintaining the device, the local laws, regulations, and codes shall be followed. The safety precautions in this Manual are only supplements to local laws, regulations, and codes. The Company shall not be liable for any of the following circumstances.

- The device is not run under the conditions of operating described in this Manual.
- The installation and operating environment is beyond the requirements of relevant international or national standards.
- The product is disassembled or changed, or the software code is modified without authorization.
- The operation instructions and safety warnings related with the product and in the documents are not followed.
- Damage of the device is caused by abnormal natural environment (force majeure, such as earthquake, fire, and storm).
- Transportation damage is caused during customer's own transportation.
- The storage condition does not meet the requirements of the product related documents and causes damage.

2.1.2 General Requirements

	<p>Operating when the power is on is strictly prohibited during installation.</p>
	<p>It is strictly prohibited to install, use, and operate any outdoor equipment or cables (including but not limited to transporting equipment, operating equipment and cables, plugging and removing signal ports connected to the outdoor, working at altitude, and outdoor installation) in severe weather, such as thunder, rain, snow, and gale level 6.</p>

	<p>In case of any fire, evacuate the building or equipment area and press the fire alarm bell or dial the fire call. Under any circumstances, re-entry into a burning building is strictly prohibited.</p>
	<p>Under no circumstances should the structure and installation sequence of the device be changed without the manufacturer's permission.</p>
	<p>The battery terminal components shall not be affected during transportation. And, the battery terminal bolts shall not be lifted or transported.</p>
	<p>It is strictly prohibited to alter, damage or block the marks and nameplates on the device.</p>
	<p>The composition and working principle of the entire photovoltaic power generation system, as well as the relevant standards of the country/region where the project is located shall be known fully.</p>
	<p>After the device is installed, the empty packing materials, such as cartons, foam, plastics, and cable ties, shall be removed from the device area.</p>

2.1.3 Personnel Safety

- When operating the device, appropriate personal protective equipment shall be worn. If any fault that may lead to personal injury or damage of the device is found, immediately terminate the operation, report to the responsible person, and take effective protective measures.
- Before using any tools, learn the correct method of using the tool to avoid injuries and damage of the device.
- When the device is running, the temperature of the case is high, which may cause burns. Therefore, do not touch the case.
- In order to ensure personal safety and normal use, reliable grounding should be carried out before use.
- Do not open or damage the battery. The electrolyte released is harmful to skin and eyes, so avoid touch it.
- Do not place irrelevant items on the top of the device or insert them into any part of the device.
- Do not place flammable items around the device.
- Never place the battery in the fire to avoid explosion and prevent the personal safety from being endangered.
- Do not place the battery module in water or other liquids.

- Do not short-circuit the battery terminals, because short-circuiting of the battery may cause combustion.
- The battery may pose a risk of causing electric shocks and large short-circuit currents. When using the battery, the following precautions should be paid attention to:
 - a) The metal objects, such as watch and rings, shall be removed.
 - b) Tools with insulated handles should be used.
 - c) Rubber gloves and shoes should be worn.
 - d) The charging power supply shall be disconnected before connecting or disconnecting terminals of the battery.
 - e) Check whether the battery is accidentally grounded. If the battery is accidentally grounded, remove the power supply from the ground.
- Do not clean the internal and external electrical components of the cabinet with water or detergent.
- Do not stand, lean or sit on the device.
- Do not damage any modules of the device.

2.2 Personnel Requirements

- The personnel in charge of installation and maintenance must be strictly trained to understand all safety precautions and master proper operation methods.
- Only qualified professionals or trained personnel are allowed to install, operate and maintain the device.
- The personnel who operate the device, including the operators, trained personnel and professionals, must have special operation qualifications required by the local country, such as high voltage operation, working high above the ground, and special equipment operation qualification.
- The replacement of device or components (including software) must be carried out by professionals or authorized personnel.

2.3 Electrical Safety

2.3.1 General Requirements



Before carrying out electrical connections, ensure that the device is not damaged, or an electric shock or fire may occur.



Never install or remove any power cables when the power is on. The electric arcs or sparks may be generated at the moment when the power cable contacts with the conductor, which may cause fire or personal injuries.

- All the electrical connections must meet the electrical standards of the country/region where the project is located.
- The cables prepared by users themselves shall comply with local laws and regulations.
- Special insulating tools should be used in high-voltage operations.
- Before connecting the power cord, ensure that the label identification on the power cord is correct.
- Operations on the device are allowed only five minutes after the device is completely powered off.
- The insulation layer of the cable may be aged or damaged when the cable is used in a high temperature environment. Therefore, the distance between the cable and the heat source must be at least 30mm.
- Cables of the same type should be bundled together. Whereas, the cables of different types should be routed at least 30mm apart, and shall not be wrapped together or crossed.

2.3.2 Grounding Requirements

- When installing the device to be grounded, the protective grounding wire must be installed first; when removing the device, the protective grounding wire must be removed at last.
- It is forbidden to destroy the grounding conductor.
- It is forbidden to operate the device without a grounding conductor installed.
- The device shall be permanently connected to the protective grounding wire. Before operating the device, electrical connection of the device shall be checked to ensure that the device is reliably grounded.

2.4 Installation Environment Requirements

- Do not install or use this product in an environment where the temperature is lower than -10 °C or higher than 50 °C.
- It should be installed in a dry and well-ventilated environment to ensure good heat dissipation performance.
- The product can be installed at a maximum altitude of 2,000m.
- The installation position should be away from the fire source.
- The product should be installed and used away from children and animals.
- The installation position should be far away from water sources, such as faucets, sewer pipes, and sprinklers, to avoid entering of water.
- The device should be placed on a firm and flat supporting surface.
- Do not place any inflammable or explosive items around the device.
- When the device is running, do not block the ventilation vent or heat dissipation system to prevent fire caused by high temperature.



The operation and service life of the energy storage is related to the operating temperature. The energy storage should be installed at a temperature equal to or better than the ambient temperature.



Max+50°C



Min-10°C



RH.+5%~+95%

3 Product Introduction

3.1 Battery Specifications

Product model	SR-EOS05B	SR-EOS10B
Rated voltage	51.2V	51.2V
Rated capacity	100Ah	200Ah
Rated energy	5.12kWh	10.24kWh
Weight	47kg	88kg
Dimensions (L*W*H)	725*460*100mm	1014*620*205mm
Max. charging current	100A	150A
Max. discharging current	100A	200A
Peak charging current	110A (3S)	200A (3S)
Peak discharging current	110A (3S)	220A (3S)
Screen	LCD Screen	Touch Screen
Battery type	LFP	
Life time(25°C)	20 Years	
Life cycles (80% DOD,0.5C,25°C)	6000 Cycles	
Max.charging voltage	57.6V	
Over discharge voltage	44.8V	
Max.Number of parallel	9	
Communication interfaces	CAN/RS485/USB/WIFI/Bluetooth	
Lithium Battery Standard	UN38.3,MSDS,IEC 62619: 2017,EN IEC 61000-6,UL1973	
Storage time / temperature	6 months @25°C;3 months @35°C;1 months @45°C;	
Charging temperature range	0 ~ 45°C	
Discharging temperature range	-10 ~ 45°C	

Cooling method	Natural cooling	
Enclosure protection rating	IP30	IP65
Operation Environment	Indoor	Indoor&Outdoor

3.2 Model Coding

The model coding of the energy storage battery is as follows:

SR-EOS05B

① ② ③

Identifier	Meaning	Value
①	Product type	EOH: horizontally-mounted EOV: vertically-mounted EOS: wall-mounted
②	Energy storage capacity level	05: The battery capacity is 5kWh 10: The battery capacity is 10kWh
③	Product category	B: Energy storage battery C: Power conversion module S: Energy storage system

3.3 Appearance Description

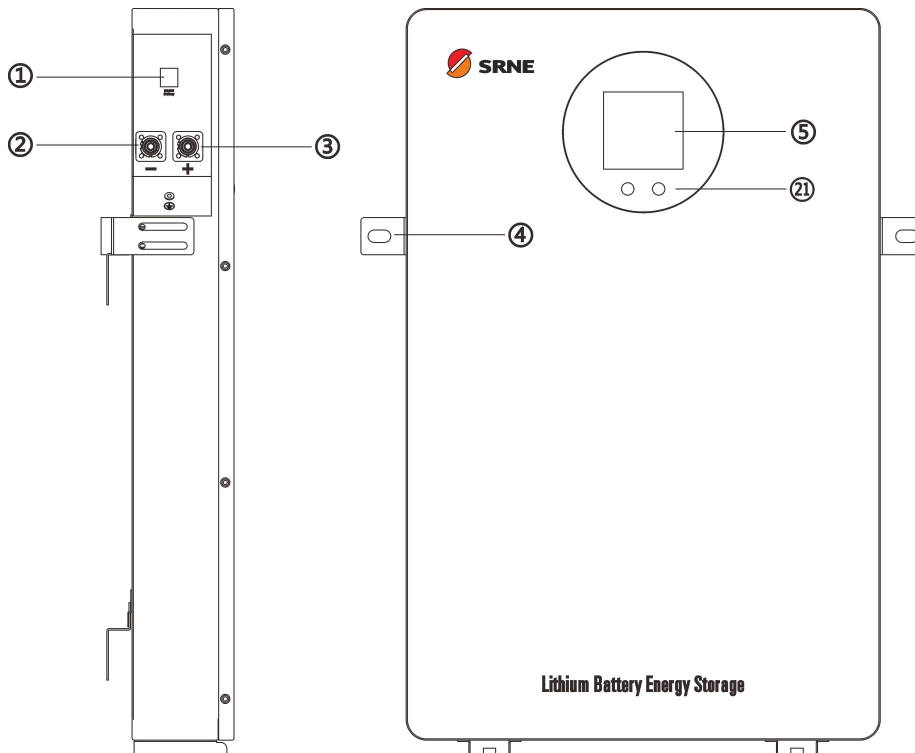

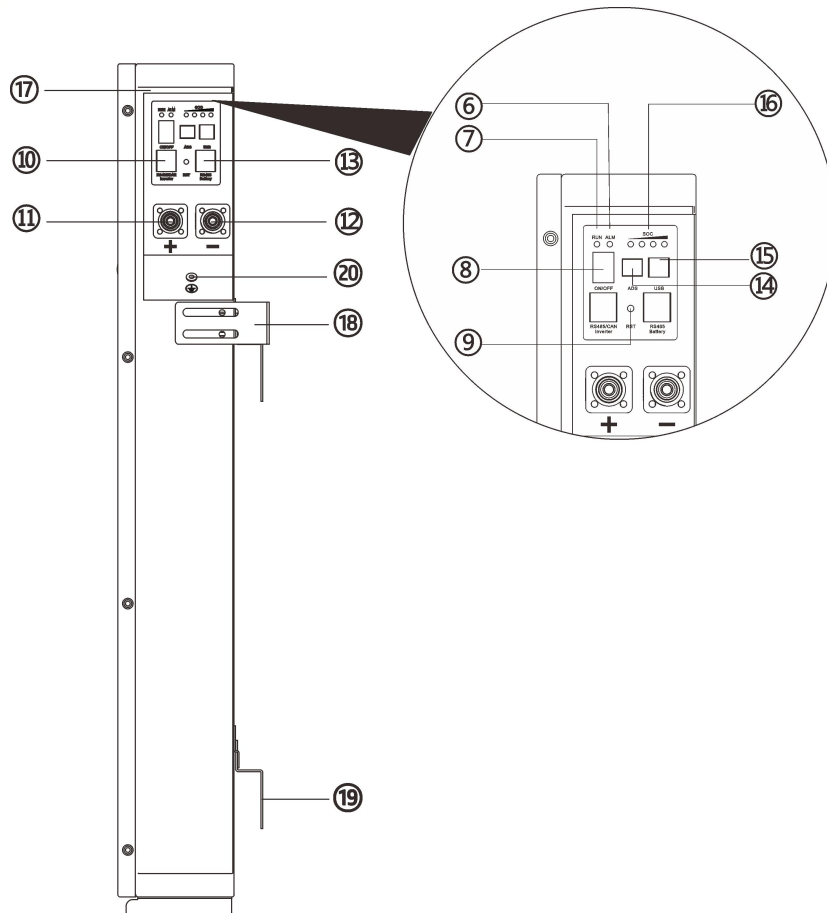

① RS485 (Connect other battery)	② Battery Negative	③ Battery Positive	④ Side fastener
⑤ LCD Screen	⑥ LED(ALM)	⑦ LED(RUM)	⑧ Turn On/Off
⑨ Reset	⑩ RS485/CAN (Connect inverter)	⑪ Battery Positive	⑫ Battery Negative
⑬ RS485 (Connect other battery)	⑭ Address	⑮ USB (Connect PC)	⑯ SOC (State of Capacity)
⑰ Handle	⑱ Side fastener	⑲ Mounting Frame	⑳ Grounding screw
㉑ Button			

Communication interface definition

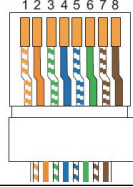
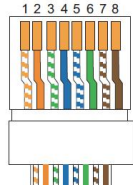
Number	Communication	Interface Type	Picture	instruction
① ⑬	RS485	RJ45		1-RS485-B 2-RS485-A 7-RS485-A 8-RS485-B
⑩	RS485/CAN	RJ45		1-RS485-B 2-RS485-A 3-GND 4-CAN-H 5-CAN-L 6-GND 7-RS485-A 8-RS485-B

4 Application Scenarios

The lithium iron phosphate batteries with high performance and long service life are used in the energy storage module. Meanwhile, the modular structure design is adopted. Each energy storage module is internally integrated with the intelligent BMS system, which can be easily expanded and can be combined into 45Kwh battery pack at most.

The battery storage can be combined with SRNE brand inverter to form an on-grid or off-grid photovoltaic system, which can solve the problem of electricity consumption in areas without electricity.

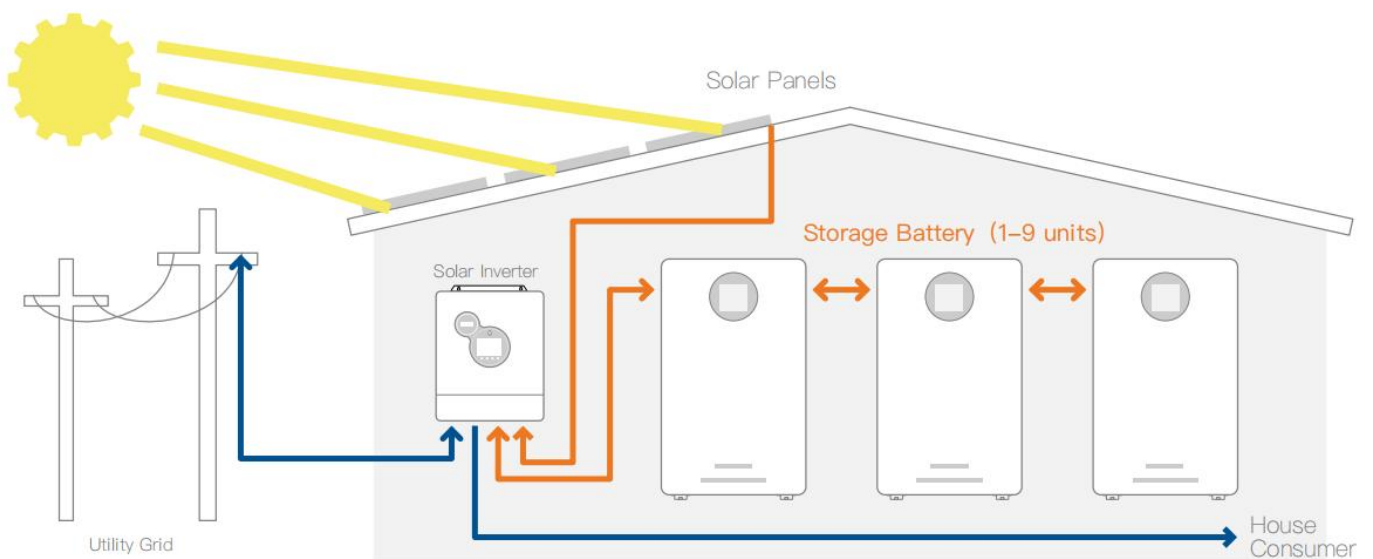

5 System Installation



5.1 Inspections before Installation

Inspection of outer package

Before opening outer package of the energy storage, check if there is any visible damage on the outer package, such as holes, cracks or other signs of possible internal damage, and check the type of energy storage. If there is any abnormality on the package or model of the energy storage is inconsistent, do not open it and contact us as soon as possible.



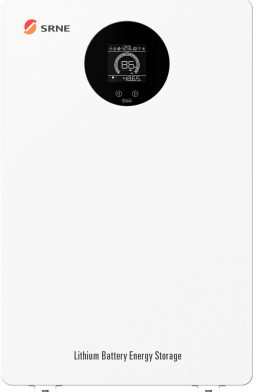
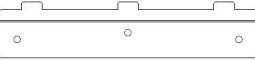
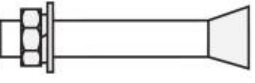
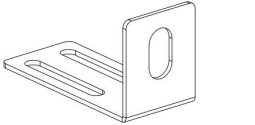
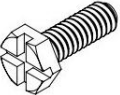

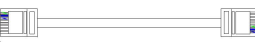

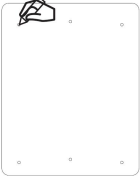



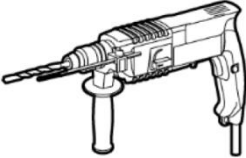

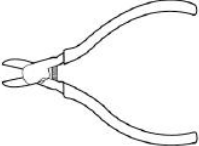
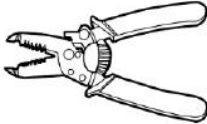
Inspection of deliverables

After opening outer package of the energy storage, check if the deliverable is complete and whether there is any visible external damage. If any items are missing or damaged, please contact us.

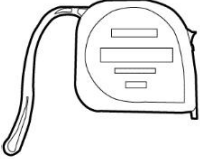
NO.	Picture	Item	Quantity	Specification
1		Battery Pack	1	51.2V,5.12kWh
2		Mounting Frame	2	350*77mm
3		Mounting Frame Screw	6	M8*60 expansion bolt
4		Side fastener	2	80*40*36mm
5		Screw	4	M5*12
6		Power Cable	2	1.5m
7		Signal cable	1	RJ45,1.5m

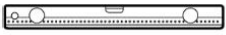
8		Grounding Wrie	1	1m
9		Installation auxiliary board	1	400*500mm

5.2 Preparation of Tools and Meters

Types	Tools and meters		
Installation tool			
			  
			
Personal protective equipment			
			

5.3 Selection of Installation Location

5.3.1 Basic Requirements

- When the energy storage is running, the temperature of the case and the radiator will be high. Therefore, do not install them in a place that is easy to touch.
- Do not install in areas where flammable and explosive materials are stored.
- If the energy storage is installed in areas with salt damage, it will be corroded and may cause fire. Therefore, do not install it outdoors in areas with salt damage. The areas with salt damage are defined as the areas which are not 500m away from shore or will be affected by sea breezes. The areas affected by

the sea breezes vary depending on meteorological conditions (e.g. typhoons, monsoons) or topographical conditions (dams, hills).

- Do not install in the place where children can touch.
- The energy storage cannot be installed forwardly, horizontally, inversely, backwardly or sideways.
- When drilling holes on walls or ground, the goggles and protective gloves shall be worn.
- During drilling, the device should be shielded to prevent debris from falling into the device. After drilling, the debris shall be cleaned up in time.
- When handling any heavy objects, you should be prepared to bear loads to avoid being crushed or sprained.
- When handling the device by hand, wear protective gloves to avoid injury.

5.3.2 Installation Space Requirements

Floor Mount: The battery should be placed in the right position first, and the installation site should be smooth and the wall should be solid, and the distance between the batteries should be greater than 200-350mm.

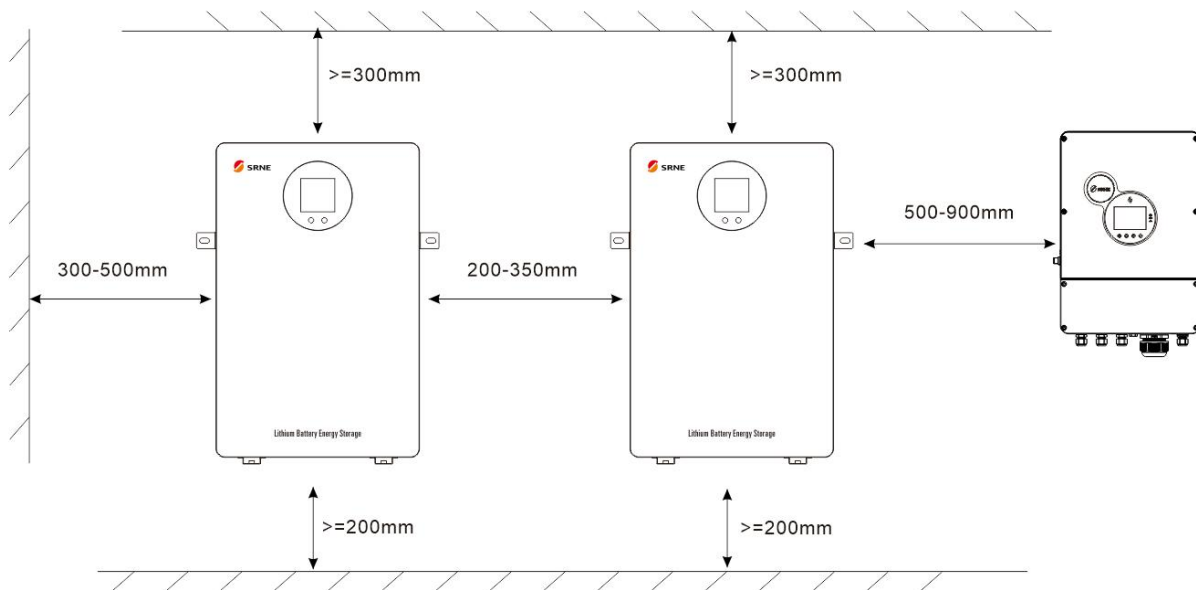

Wall mount: The battery should be placed in the right position first, and the installation site should be smooth and the wall should be solid, and the device is 200mm away from the ground, the distance between the batteries should be greater than 200-350mm.

5.4 Device Installation

5.4.1 Wall mount

5.4.1.1 Installation Location Selection

Determine the installation position, put the installation auxiliary board in the proper position, and mark the place where the holes need to be punched.

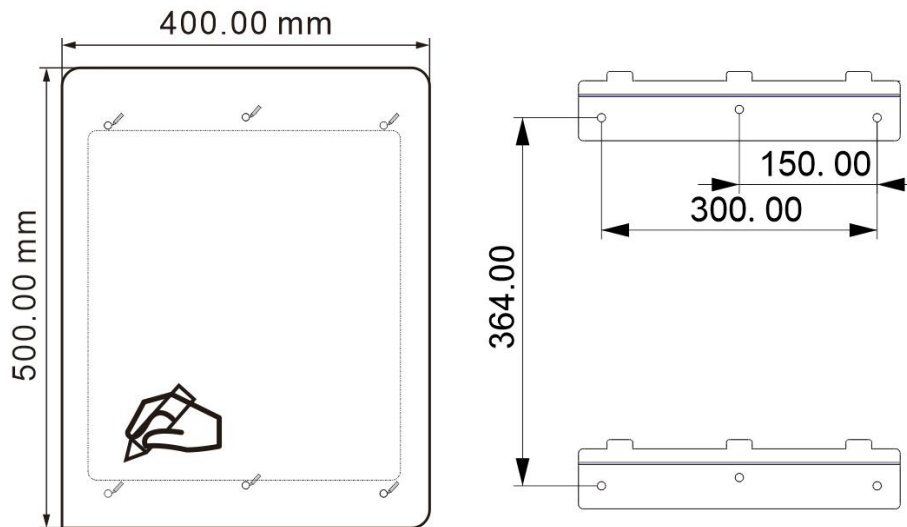

5.4.1.2 Install Expansion Bolts



In order to avoid electrical shock or other injury, inspect existing electronic or plumbing installations before drilling holes.



Choose suitable firm wall with thickness greater than 80mm.

Drill 6 holes according to the hole position, it is $\phi 8$ with depth of 45~50mm. Hammer the M8 screws to the above holes, and screw the nut.

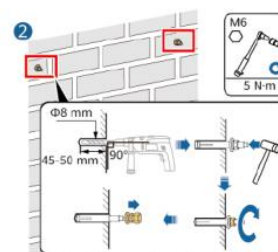
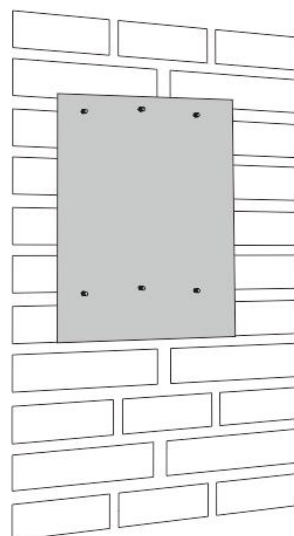

5.4.1.3 Fix Mounting Frame

Make the convex side outward and fix the mounting frame to the 6 screws.

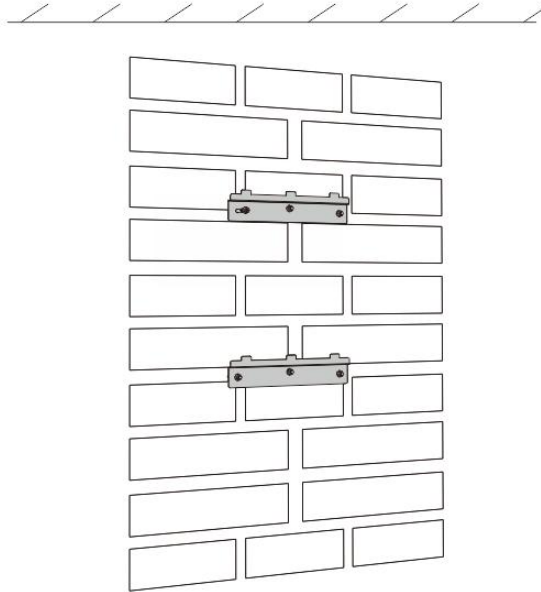

5.4.1.4 Install Battery Pack



The battery pack is very heavy, which requires multiple people to install.

Keep the battery balanced, and then slowly hang the battery on the frame through the match hooks.

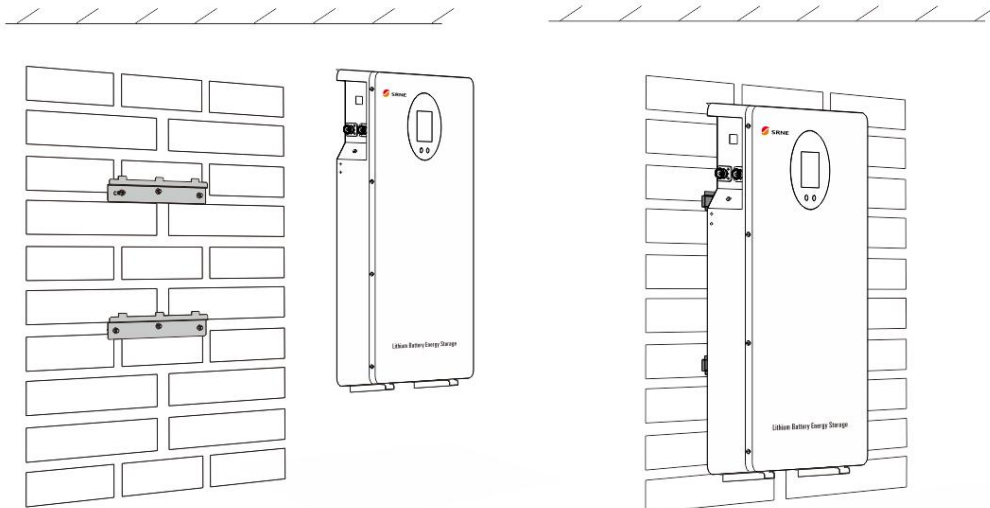

5.4.2 Floor Mount

5.4.2.1 Install Expansion Bolts



In order to avoid electrical shock or other injury, inspect existing electronic or plumbing installations before drilling holes.

Drill 2 holes according to the hole position, it is $\phi 8$ with depth of 45~50mm. Hammer the M8 screws to the above holes, and screw the nut.

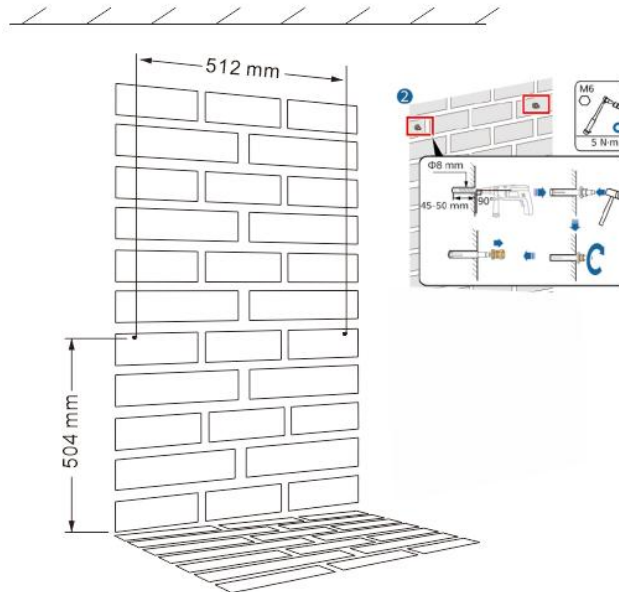

5.4.2.2 Install Battery Pack

Place the battery on a flat, firm floor and install the fixing accessories.

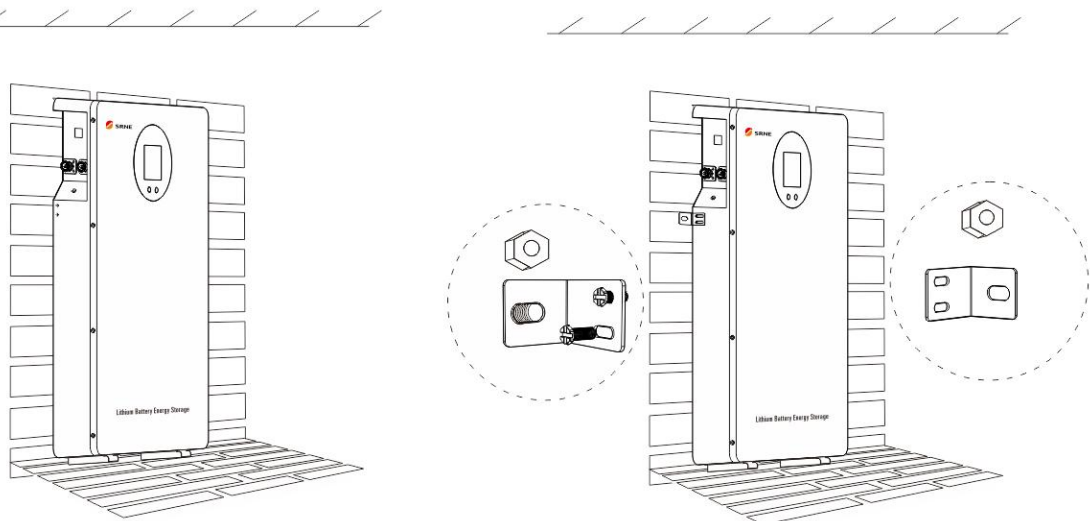

6 Electrical Connection





Before electrical connection, please ensure that the switches of the energy storage are in the "OFF" state. Otherwise, the high voltage of the device may cause electric shock.



The operations related to electrical connections must be carried out by professional electrical technicians. When carrying out electrical connections, the operator must wear personal protective articles.

6.1 Preparation of Cables

No.	Cables	Description	Recommended specifications	Source
1	Power Cable	Power cable between the storage battery and inverter		Provide with the product together
2	Signal line	Signal cable between battery modules or between battery and inverter		Provide with the product together
3	Ground wire	Ground cable between the storage battery modules		Provide with the product together
4	Photovoltaic input line	Cable between the photovoltaic panel and power module	Cable diameter 6mm ² /10AWG	Prepare by the user itself
5	AC input line	Cable between AC input and power module	Cable diameter 10mm ² /7AWG	Prepare by the user itself
6	AC output line	Cable between AC output and power module	Cable diameter 10mm ² /7AWG	Prepare by the user itself

6.2 Electrical Connection Of One Battery Module

6.2.1 Connecting Grounding Wire

Each energy storage battery module shall be connected with the grounding wire provided with the product together.

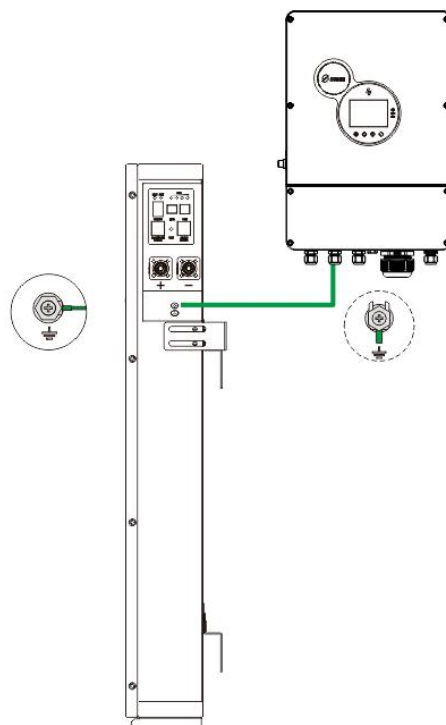

6.2.2 Connecting Power Cord

When connecting the battery wiring, please make sure that the battery switch is off and the indicator light is off.

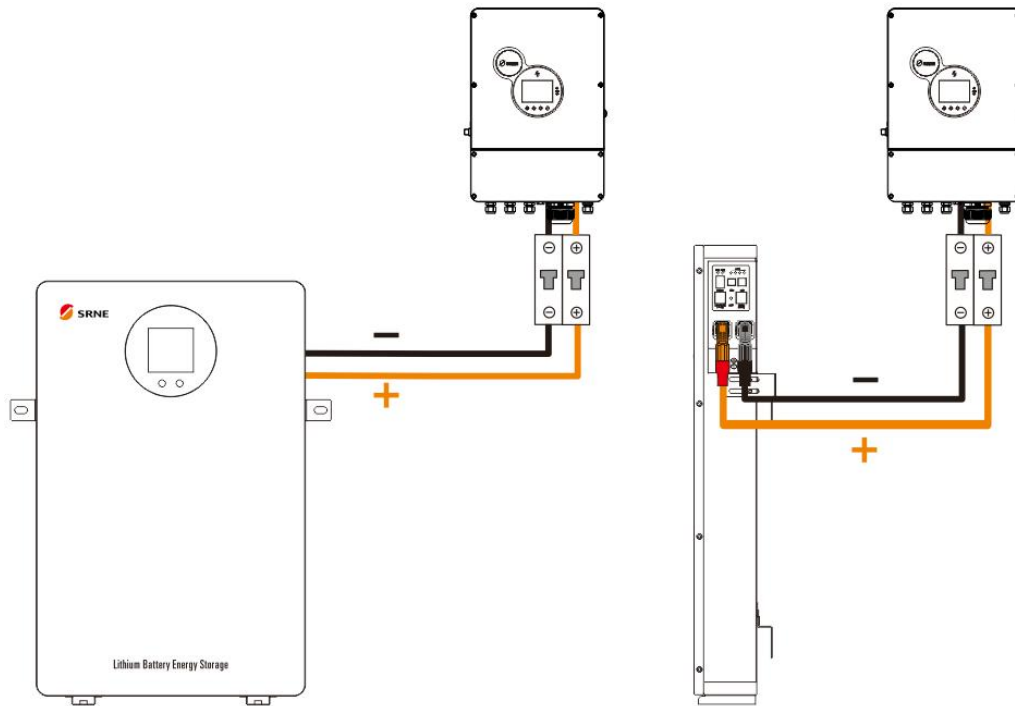

6.2.3 Connecting Signal Line

The signal line shall be used to connect RS485-Inverter interface for battery module and inverter.

The communication port of the SRNE brand inverter needs to be connected to the RS485-2 interface.

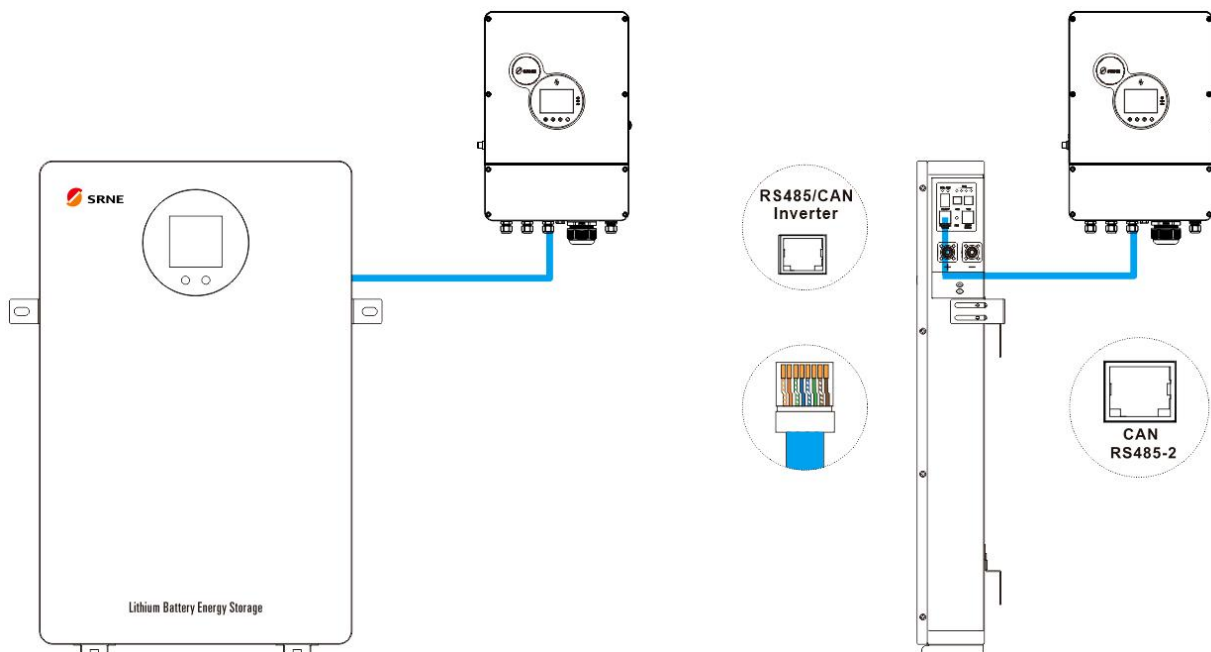



When connecting the inverter, the communication line must be connected and the communication protocol must be consistent.



The communication cable connected to the SRNE brand inverter is not a standard network cable. If you use a standard network cable, please cut off pins 1 and 2 for connection.

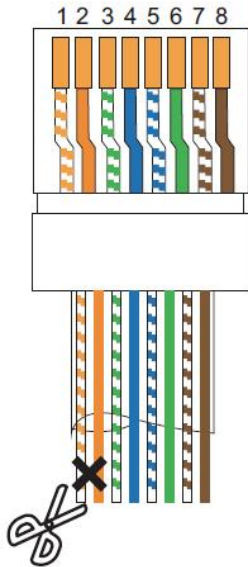

If you use a standard network cable to connect the inverter of the srne brand		
PIN1	White-orange	cut off
PIN2	Orange	cut off
PIN3	White-green	
PIN4	Blue	CAN-H
PIN5	White-blue	CAN-L
PIN6	Green	
PIN7	White-brown	RS485-A
PIN8	Brown	RS485-B

6.2.4 Energy Storage Battery Module Address Setting

When using a single battery, please set the address to 0.

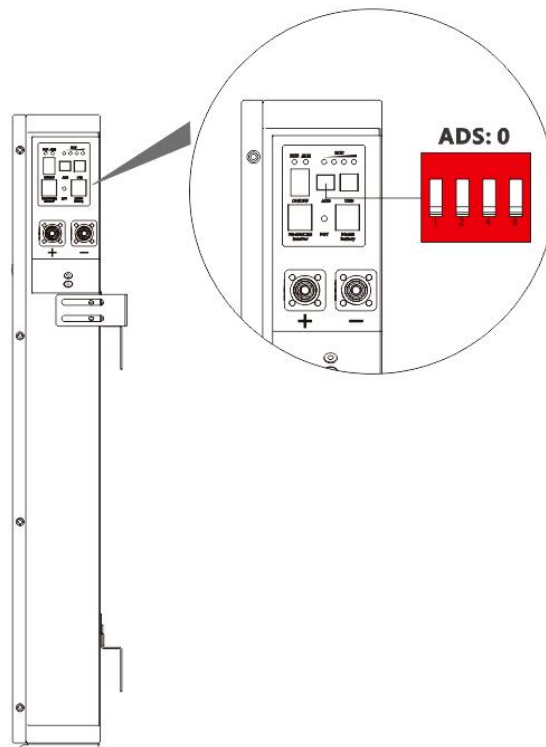

6.3 Electrical Connection Of Multiple Battery Modules

6.3.1 Connecting Grounding Wire

Each energy storage battery module shall be connected with the grounding wire provided with the product together. If there are multiple batteries, you need to connect the ground wire of each battery.

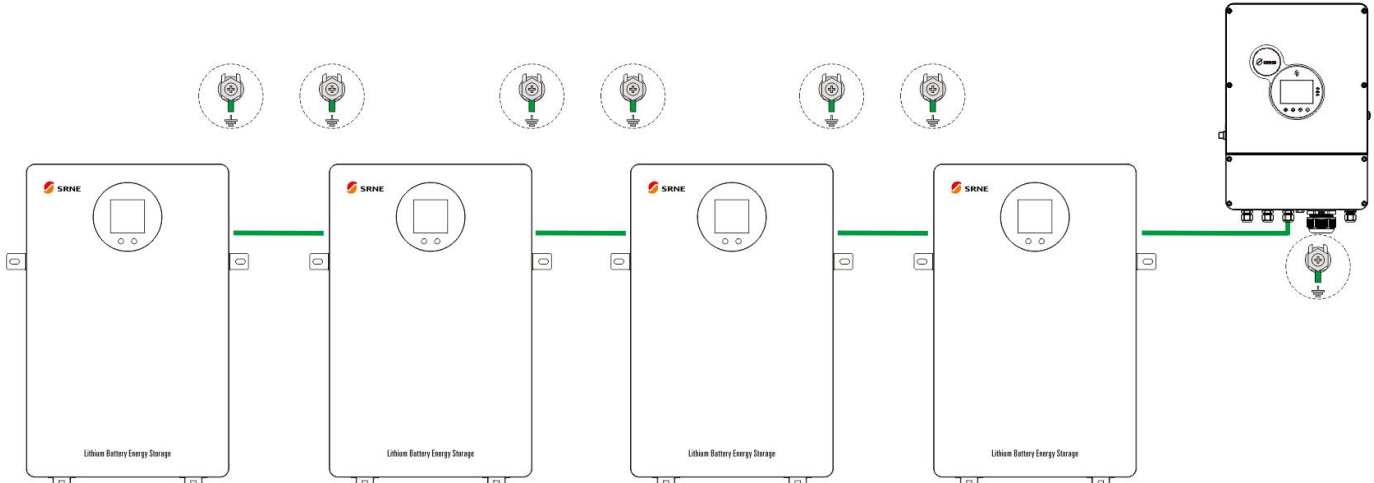

6.3.2 Connecting Power Cord

If there are 2 batteries used in parallel, you need to connect the power cord of each battery.

Parallel connection cable of battery modules are optional products. If necessary, please contact your local dealer.

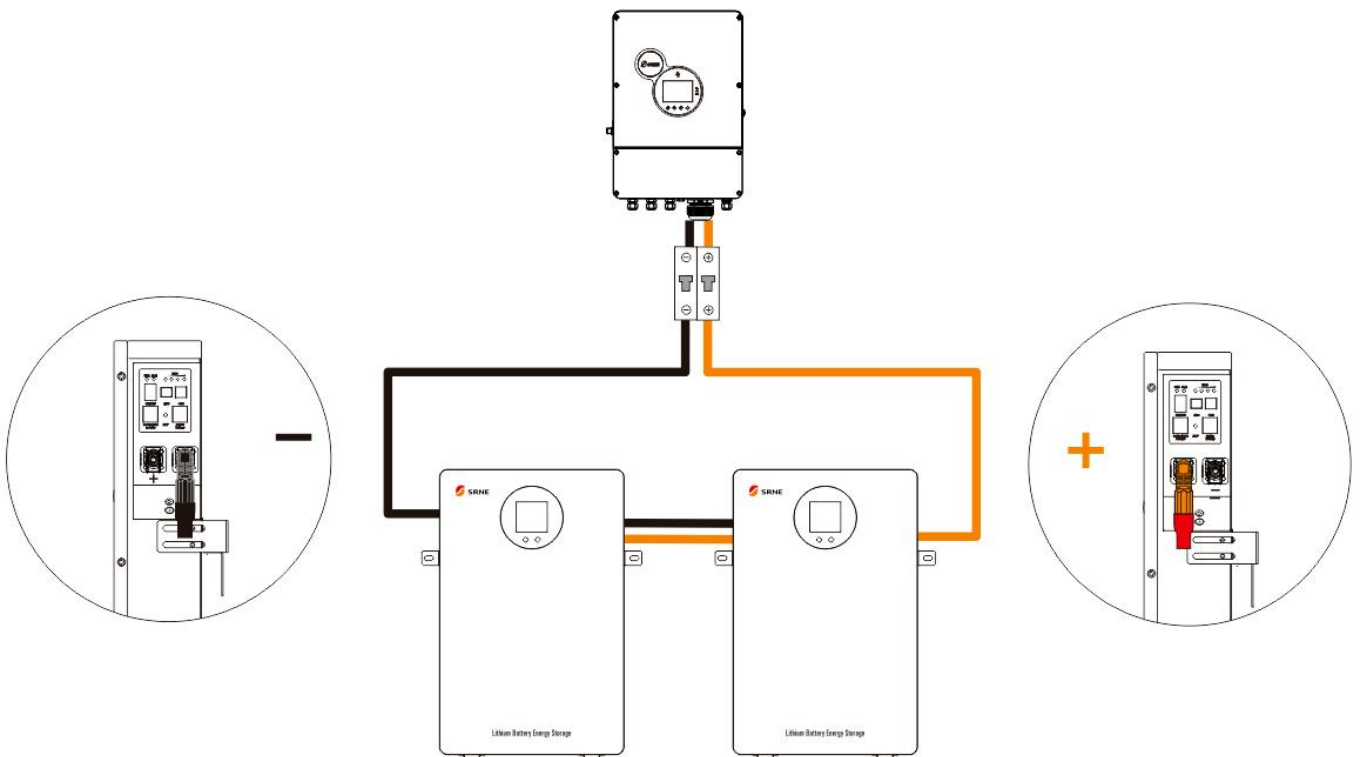

If multiple batteries are used in parallel , Bus bar is required.

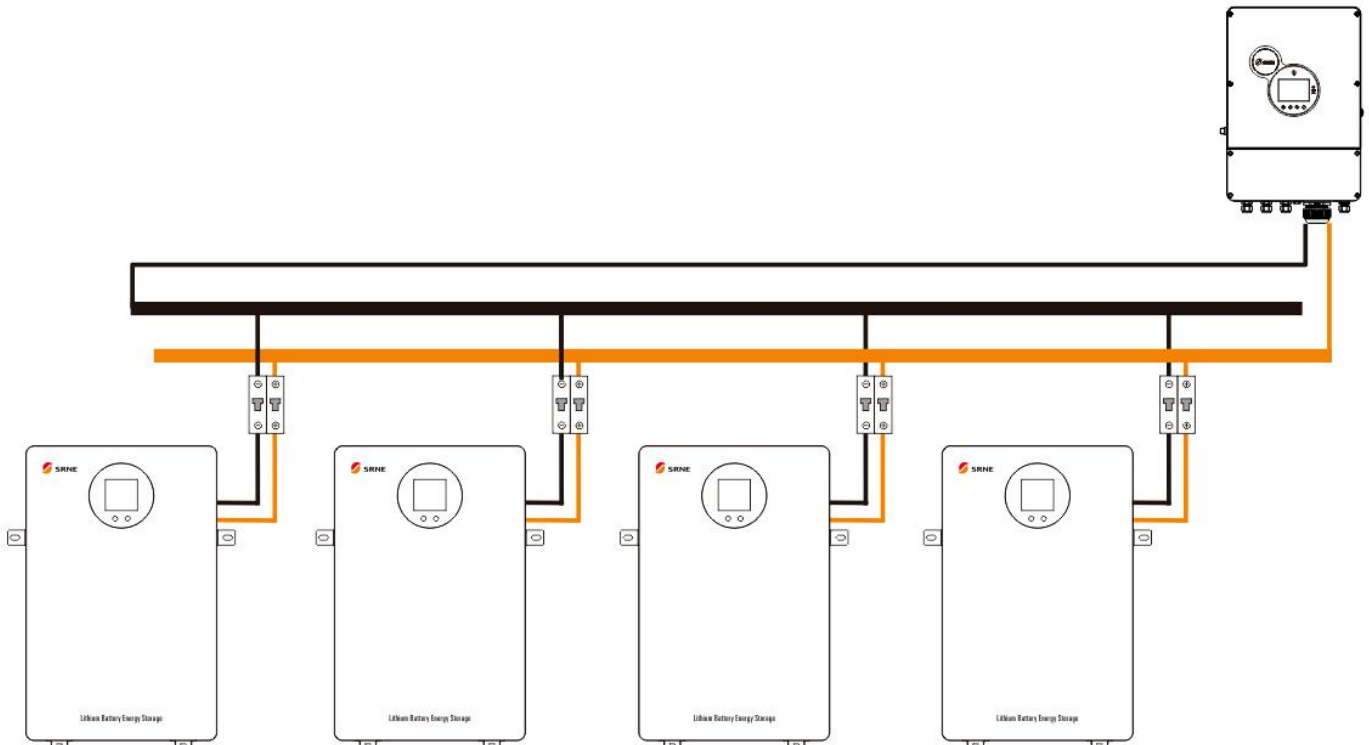

6.3.3 Connecting Signal Line

If there are multiple batteries, you need to connect the communication line of each battery. Battery and battery connection use RS485-Battery interface, battery and inverter connection need RS485-Inverter interface.

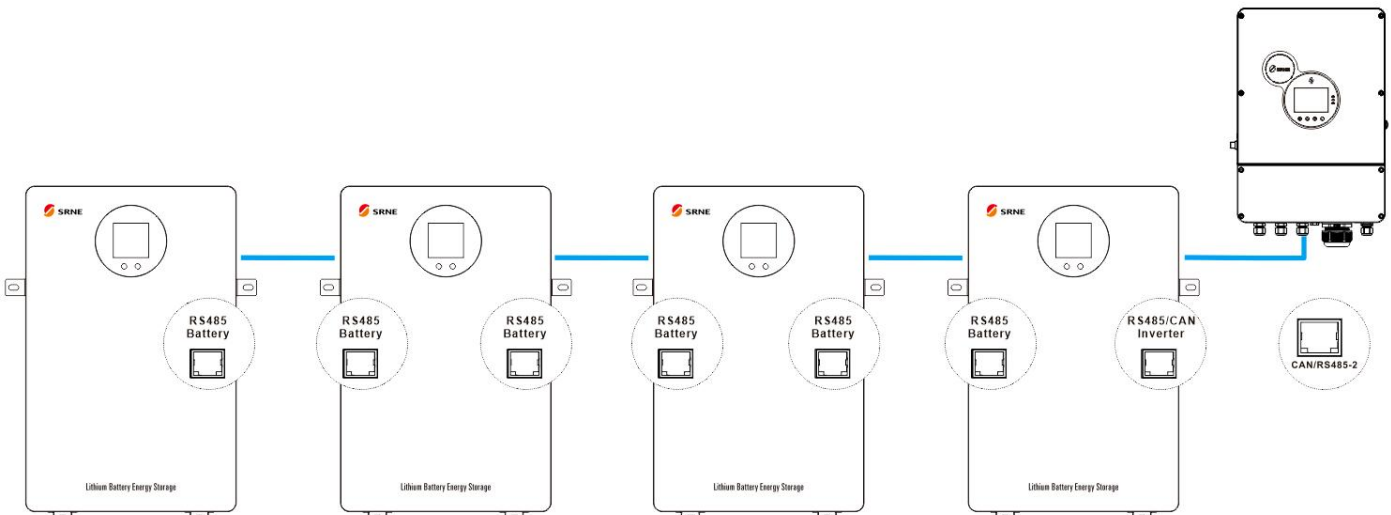





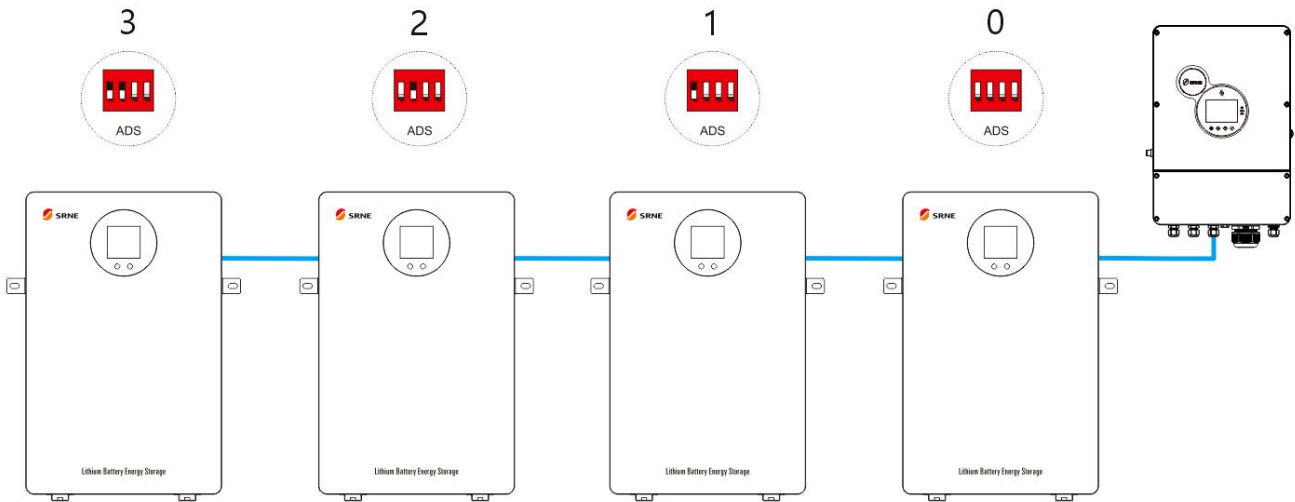



6.3.4 Energy Storage Battery Module Address Setting

If multiple energy storage battery modules are used in parallel, the address of the energy storage battery module needs to be set. The address should be set as 0~8, and the address of each module cannot be repeated.



The address of the battery connected to the inverter must be set as 0.

Multiple batteries parallel DIP switch location description, up to 9 batteries can be used in parallel.

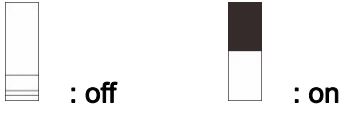
Addr	DIP Switch Position	Master or Slave Battery	Connect the inverter
0		Master	√
1		Slave1	×
2		Slave2	×
3		Slave3	×
4		Slave4	×
5		Slave5	×
6		Slave6	×
7		Slave7	×
8		Slave8	×
			

7 System Debugging

7.1 Inspections Before Power-On

No.	Inspection items	Acceptance criteria	Validation
1	The energy storage is installed in place	The installation is correct, secure and reliable.	<input type="checkbox"/> Yes <input type="checkbox"/> No
2	The installation environment meets requirements	The installation space is reasonable and the environment is clean and tidy without any construction	<input type="checkbox"/> Yes <input type="checkbox"/> No
3	The power cord is correctly connected	The positive and negative terminals are connected correctly without any missing.	<input type="checkbox"/> Yes <input type="checkbox"/> No
4	The signal line is correctly connected	The signal line is connected reliably, and there is no wrong position	<input type="checkbox"/> Yes <input type="checkbox"/> No
5	The grounding is reliable	The grounding wire is correctly and reliably connected.	<input type="checkbox"/> Yes <input type="checkbox"/> No
6	The switch of the energy storage battery module is off	All switches connected to the energy storage are in the "OFF" state.	<input type="checkbox"/> Yes <input type="checkbox"/> No

7.2 Power-On of Battery Module

7.2.1 Power-up Sequence

After the battery is connected to the inverter, please power on in the following order.

First, Turn on the breaker switch, if there are multiple battery modules, turn on all the breaker switches.

Secondly, turn on the battery switch button and the battery starts to work. If there are multiple modules, please turn on the power switch one by one according to the address sequence.

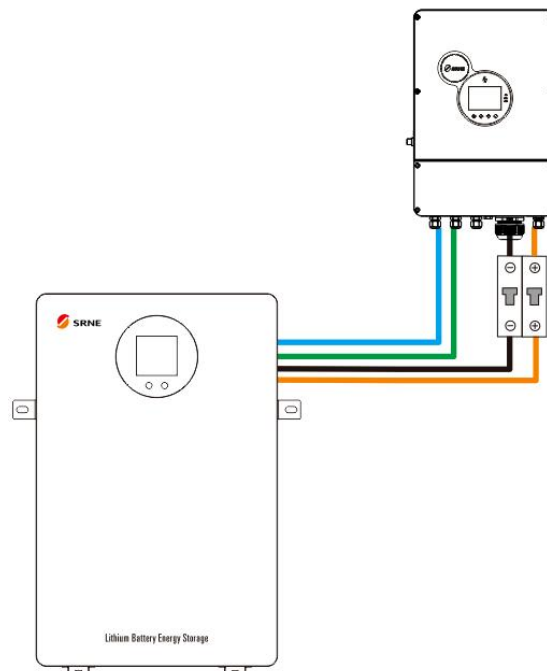

7.2.2 System Status Indication

After the battery switch button is turned on, the LED indicator will light up or flash. The meaning of the LED indicator is as follows.

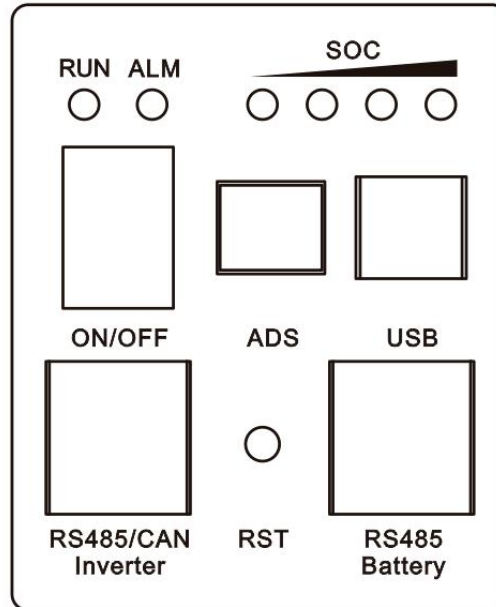





System Status	Events	RUN	ALM
POWER OFF	Power Off	OFF	OFF
Steady	Normal	Blinking1	OFF
	Alarm	Blinking1	Blinking3
Charging	Normal	ON	OFF
	Alarm	ON	Blinking3
	Over Charge Protection	ON	OFF
	High temperature, Over Current	OFF	ON
Discharging	Normal	Blinking3	OFF
	Alarm	Blinking3	Blinking3
	Over Discharge Protection	OFF	OFF
	Over Current , Short Current	OFF	ON

LED blinking description

Blinking	LED ON	LED OFF
Blinking1	0.25S	3.75S
Blinking2	0.5S	0.5S
Blinking3	0.5S	1.5S

7.2.3 Capacity indicator

Capacity indicator LED	SOC
	0 ~ 25%
	25 ~ 50%
	50 ~ 75%
	75 ~ 100%





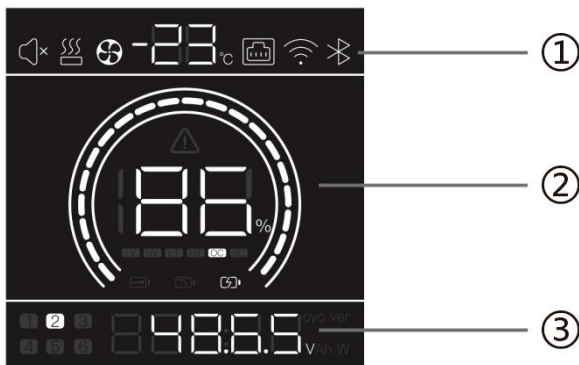

7.2.4 LCD Screen

7.2.4.1 Page Introduction









ID	Value
①	Battery temperature and status Info.
②	SOC and warning
③	Detailed information

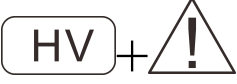

Status information is as follows.

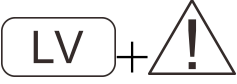
N0.	Graphical symbols	Function
1		BMS and LCD communication function indication
2		WiFi function indication. The icon flashes, indicating that the network connection is not successful.
3		Bluetooth function indication
4		Buzzer mute indication(some products do not have this function)
5		Battery heating indication(some products do not have this function)
6		Battery cooling indication(some products do not have this function)



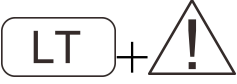
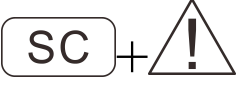

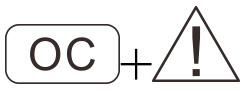

7.2.4.2 Warning Notes

Warning and protection information is as follows.

NO.	Graphical symbols	Warning and Protection	Warning and fault description
1		Over voltage Warning	The battery voltage exceeds the warning value, but the BMS will not stop charging, and the inverter needs to actively stop charging.
		Over voltage Protection	The battery voltage exceeds the protection value, the BMS will actively stop charging.
2		Over discharge Voltage Warning	The battery voltage is lower than the warning value, but the BMS will not stop discharging, and the inverter needs to actively stop discharging.
		Over discharge Voltage Protection	The battery voltage is lower than the protection value, the BMS will actively stop discharging.
3		Over Temperature Warning	The battery temperature is higher than the warning value, but the BMS will not stop charging and discharging, and the inverter needs to actively stop charging and discharging.
		Over Temperature Protection	The battery temperature is higher than the protection value, the BMS will actively stop charging and discharging.
4		Low Temperature Warning	The battery temperature is lower than the warning value, but the BMS will not stop charging and discharging, and the inverter needs to actively stop charging and discharging.
		Low Temperature Protection	The battery temperature is lower than the protection value, the BMS will actively stop charging and discharging.
5		Short Circuit Protection	The battery output is short-circuit protected, and the BMS stops

			discharging.
6		Overcurrent Protection	The charging current or discharging current is too large, the BMS stops charging or discharging
7		Hardware failure	Hardware failure, please stop using immediately, and contact a professional maintenance personnel to deal with.

7.2.4.3 Detailed information

N0.	Graphical symbols	Function
1		Battery voltage
2		Estimated discharge remaining time
3		Battery current,"+"indicates charging,"-"indicates discharging.
4		Remaining capacity of battery
5		Number of battery cycles
6		BMS version number

7.2.4.4 Key function

Short press function:detailed information toggle.

Long key function:press the key for 3 seconds at the same time to reset WiFi,the WiFi symbol will flash.



If you can't connect to the network or need to change the network environment, please reset the WiFi.

7.3 Battery Communication Protocol

The supported inverter and battery manufacturer communication protocols are as follows, and will be continuously updated.

Battery /Inverter brand	CAN protocol	485 protocol
Pylon	√	√
Growatt	√	√
Victron	√	
Goodwe	√	
Solis	√	
Luxpower	√	
Sofar	√	
KStar	√	
SMA	√	
MEGAREVO	√	
Afore	√	
SRNE		√
Deye		√
Voltronic		√
Paceic		√

7.4 WIFI Function

7.4.1 Download App

Scan the QR code to download the APP.



7.4.2 Register and Login

You need to register an account for the first time.

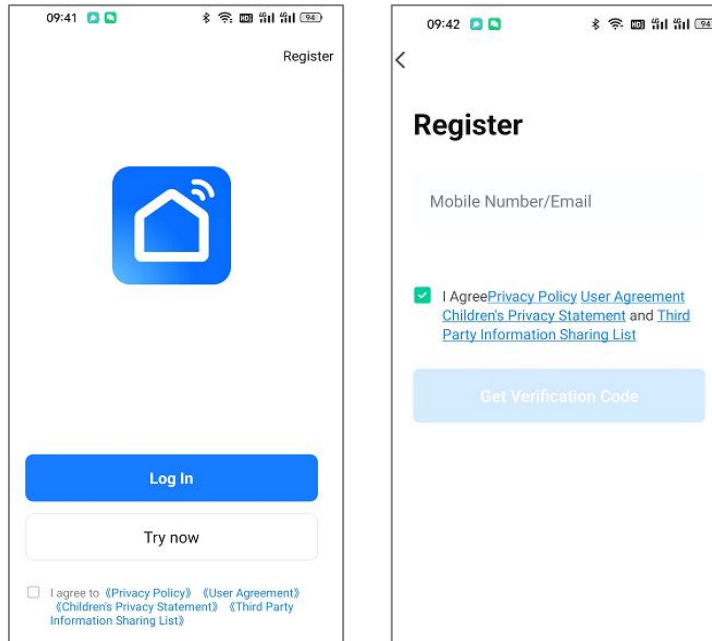

7.4.3 Add Device

Connecting the device requires turning on Bluetooth, WIFI, and location permissions.

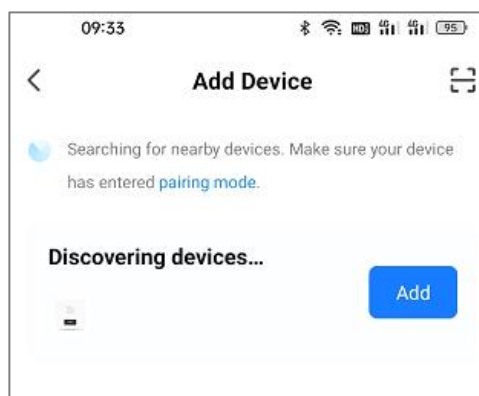
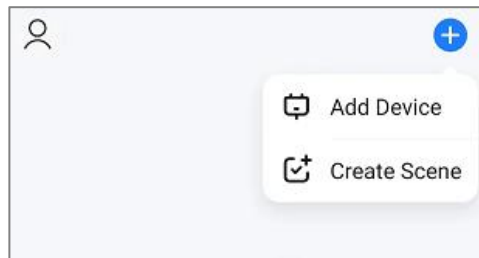

7.4.4 Connect Network

Choose WIFI and enter the password, the device starts connecting to the network.

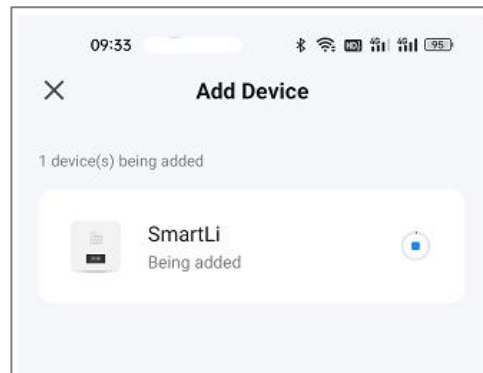
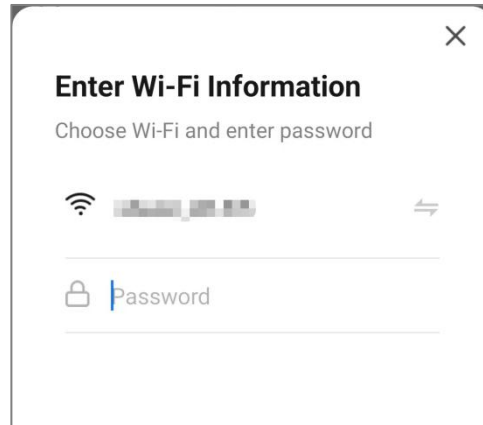

7.4.5 Reset WIFI

If you can't connect to the network or need to change the network environment, please reset the WIFI.



Only supports 2.4G band's WiFi , not supports 5G band's WiFi , please make sure that the 2.4G band of the router is turned on.

7.5 Bluetooth Function

7.5.1 Download App

Scan the QR code to download the APP.



7.5.2 Add Device

Connecting the device requires turning on Bluetooth, and location permissions.

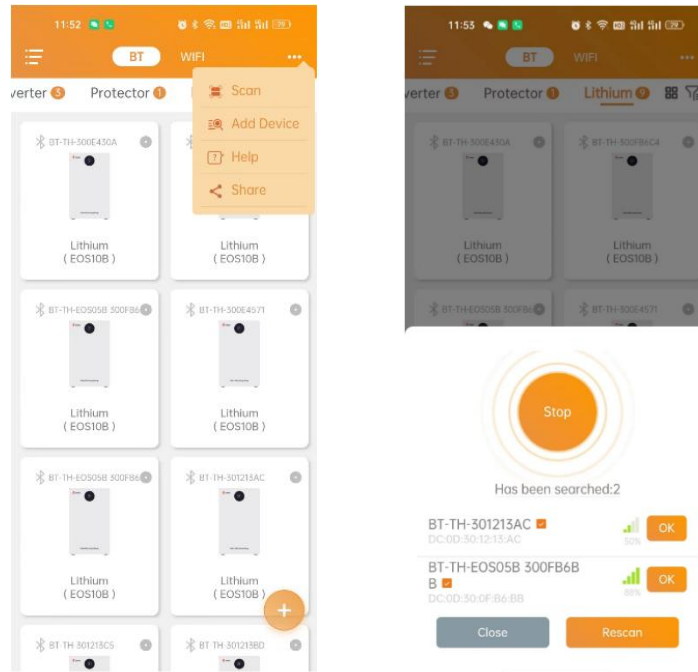

7.6 Sleep Mode

If the battery is neither charged nor discharged, it will automatically enter sleep mode after a period of time. After entering sleep mode, BMS will turn off LCD and WiFi module to save power. If you want to continue using it, please turn the power button on and off again.

8 System Maintenance

8.1 System Power-Off



After the system is powered off, the case still has residual power and heat, which may cause electric shocks or burns. Therefore, protective gloves should be worn before operating the energy storage 5 minutes after the system is powered off. Maintenance operations on energy storage should be performed only after ensuring that all indicator lights of the energy storage are off.

Power-off operation steps of the system:

Step 1 Turn off the breaker switch between the inverter and AC output (If installed).

Step 2 Turn off the breaker switch between the inverter unit and AC input (If installed).

Step 3 Turn off the breaker switch between the inverter unit and the PV string (If installed).

Step 4 Turn off the breaker switch between the inverter and battery.

Step 5 Turn off button on all storage battery modules, the energy storage is powered off successfully.

8.2 Routine Maintenance

SRNE Solar Co., Ltd.

4-5F, 13A Wutong Island, Neihuan Road, Xixiang, Shenzhen, China

T: +86 0755-26458295
F: +86 0755-27325578

E: master@szshuori.com
W: www.srnesolar.com

Page 32 of 37

To ensure the long-term and good operation of the energy storage system, it is recommended to perform the routine maintenance as described in this section.

Items	Methods	Maintenance interval
System cleanliness	Check if the radiator is covered or dirt on a regular basis.	Once every six months to one year.
Running status of system	<ul style="list-style-type: none"> Observe whether the energy storage appearance is damaged or deformed. Listen to whether the energy storage has any abnormal sound during running. When the energy storage is running, check whether the indicator of the energy storage battery is correct. 	Once every six months.
Electrical connection	<ul style="list-style-type: none"> Check if any cable connection is off or loose. Check if any cable is damaged, and especially if there are cuts on the sheath where the cable contacts with the metal surface. Check if the unused DC input terminals, energy storage terminals, COM ports, and covers are locked. 	Half a year after first debugging and testing, and once every six months to one year thereafter.
Grounding reliability	Check if the grounding cable is grounded reliably.	Half a year after first debugging and testing, and once every six months to one year thereafter.

8.3 Common Faults and Handling Methods

Faults	Handling measures
The indicator light and LCD does not work	Check whether battery is sleeping mode.If the battery is neither charged nor discharged, it will automatically enter sleep mode after a period of time.
All indicators of the battery are off	<p>If the battery power is low, you need to charge it before using it.</p> <p>If the battery is not used for a long time, it will automatically sleep, and it can be used normally after restarting.</p>
Battery overcurrent protection fault	<p>Check whether there is a short circuit in the battery wiring.</p> <p>Check whether the load power exceeds the maximum</p>
The battery cannot be charged	<p>Check if the battery is fully charged</p> <p>Check whether the ambient temperature is below -10 degrees.</p>
Communication error with inverter	<p>Check whether the communication interface is incorrectly plugged in and</p> <p>Whether the wiring is secure.</p> <p>Whether the battery address is set correctly.</p>

	Whether the protocol is secure.
WIFI communication error	Check if the router settings are correct Check whether the routing network is normal Check whether the router's 2.4G frequency band is turned on

8.4 Battery Storage and Maintenance

8.4.1 Battery Storage Requirements



Do not put the battery into fire. The battery may explode.

Do not open or damage the battery. The electrolyte flowing out from the battery is harmful to the skin and eyes. The electrolyte may also be toxic;

1. When being stored, the batteries shall be placed correctly in accordance with the marks on the packing case. Do not put them upside down or on the side.
2. When stacking up the battery packing cases, the stacking requirements on the outer package shall be met.
3. The batteries should be handled with care, and damage to batteries should be strictly prohibited.
4. Requirements for the storage environment:
 - Ambient temperature: -10°C to 55 °C, recommended storage temperature: 20°C to 30°C.
 - Relative humidity: 5%RH-80%RH.
 - Dry, well ventilated, and clean.
 - The corrosive organic solvents, gases and other substances shall be kept away.
 - Exposing to direct sunlight shall be avoided.
 - The distance from the heat source should not be less than two meters.
5. When being stored, the battery shall be disconnected from the external connection. If there is an indicator light on the battery panel, the indicator light shall be off.
6. The warehouse keeper shall make monthly statistics on the battery storage, and regularly inform the planning link of the battery inventory. If any battery has been stored for nearly 15 months (-10 °C to 25 °C), 9 months (25 °C to 35 °C), or 6 months (35 °C to 55 °C), recharging shall be arranged in time.
7. When the stored batteries are going to be delivered, the first-in first-out principle should be followed.
8. After the battery is produced and tested, it shall be recharged to at least 50% SOC before being stored. If the device will not be used for a long period of time, discharge the battery to 45% to 60% of the battery capacity and disconnect the battery output to avoid the battery runs out;
9. Do not touch the battery pack with wet hands.
10. Do not squeeze, drop, or pierce the battery.

11. The battery should always be disposed in accordance with local safety regulations.
12. The battery should be stored and recharged in accordance with this User's Manual.
13. Do not reverse polarity of the battery when storing or transporting the batteries, the batteries shall not be stacked up without protective packaging, and the number of stacked packed batteries should not exceed the number specified on the packaging.
14. All operators of the energy storage system shall comply with the user manual, installation and service manual, and quality assurance requirements. Any damage to the device resulting from neglecting or misreading of the user's manual, installation and service manual, and the quality assurance requirements will invalidate the product warranty.

8.4.2 Requirements for Charging of Battery

The batteries to be stored for a long period of time (unused, for more than 3 months) must be kept in a dry and cool place. The storage voltage is 51V~53V. The batteries should be stored in a clean environment of $23 \pm 2^{\circ}\text{C}$ and humidity of 45%~75%. If the battery will be shelved and not used for a long period of time, it should be recharged every 3 months to ensure that the battery voltage is within the above range.

As for batteries and long-term storage, routine maintenance is required. Please charge the battery to 40% SOC at a current of 0.2C according to the requirements in the table below.

Ambient temperature for storage	Relative humidity for storage environment	Storage Time	SOC
<-10°C	/	Prohibited	/
-10~25°C	5%~70%	≤12 months	30%≤SOC≤60%
25~35°C		≤6 months	
35~45°C		≤3 months	
>45°C	/	Prohibited	/

8.5 Device Cleaning

It is recommended to clean and maintain the product from time to time. When cleaning, the dust and stains on the product shall be removed with a piece of soft dry cloth or vacuum cleaner. The product shall not be cleaned with organic solvents, corrosive liquids and other cleaning products.

9 Product Dimensions and Packaging

9.1 Product Dimensions

The external dimensions of the energy storage battery module and power module are 725*480*100mm.

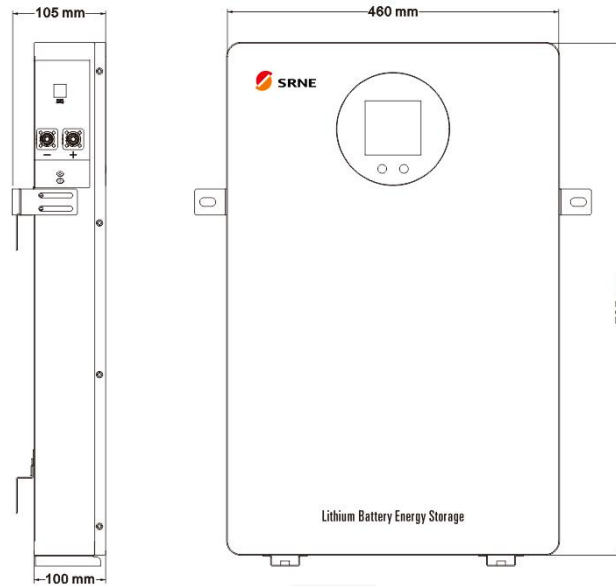

9.2 Package Dimensions



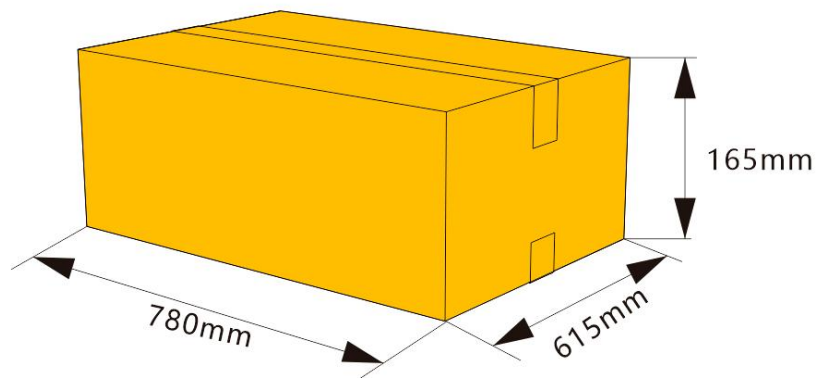

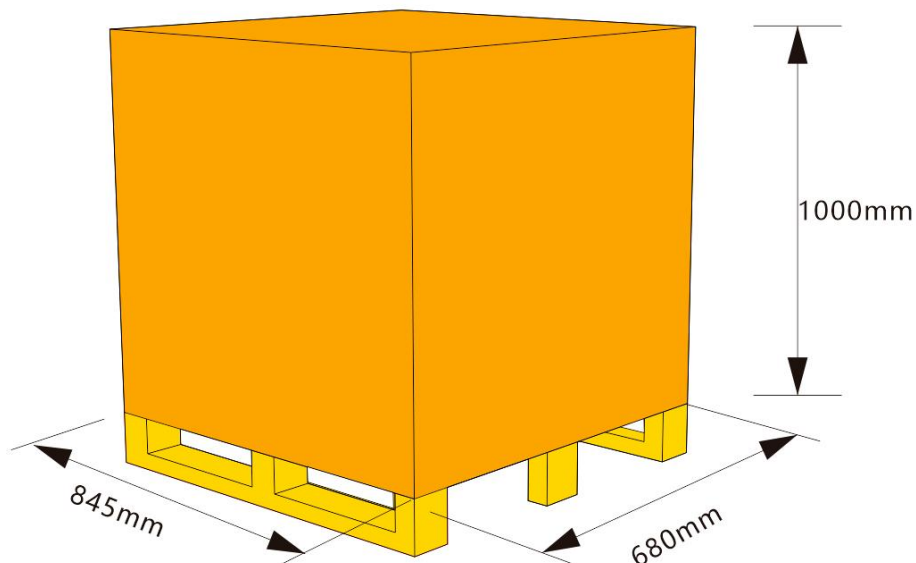

The packaging size of a single energy storage battery module is 780*615*165mm.

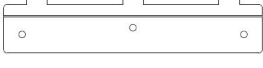
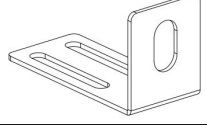
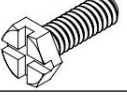

The energy storage battery module is packed in wooden cases with the size of 845*680*1000mm, the number of packs is 5PCS, and the total weight is 350kg.

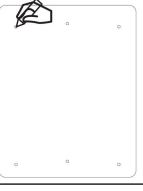

9.3 Accessories

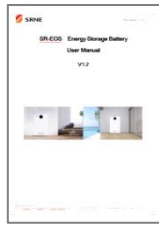
NO.	Picture	materials	Quantity	Remark
1		Mounting Frame	2	Standard
2		Side fastener	2	Standard
3		Screw M5X12	4	Standard
4		Mounting Frame Screw	6	Standard
5		Power Cable	2	Standard
6		Signal cable	1	Standard
7		Grounding Wrie	1	Standard
8		Installation auxiliary board	1	Standard
9		Parallel Power Cable	2(option)	option
10		User Manual	1	Standard